

Journal of Biomedical Optics

BiomedicalOptics.SPIEDigitalLibrary.org

Deep two-photon microscopic imaging through brain tissue using the second singlet state from fluorescent agent chlorophyll α in spinach leaf

Lingyan Shi
Adrián Rodríguez-Contreras
Yury Budansky
Yang Pu
Thien An Nguyen
Robert R. Alfano

Deep two-photon microscopic imaging through brain tissue using the second singlet state from fluorescent agent chlorophyll α in spinach leaf

Lingyan Shi,^{a,b} Adrián Rodríguez-Contreras,^c Yury Budansky,^b Yang Pu,^b Thien An Nguyen,^b and Robert R. Alfano^{b,*}

^aThe City College of the City University of New York, Department of Biomedical Engineering, 160 Convent Avenue, New York 10031

^bThe City College of the City University of New York, Institute for Ultrafast Spectroscopy and Lasers, Departments of Electrical Engineering and Physics, 160 Convent Avenue, New York 10031

^cThe City College of the City University of New York, Department of Biology, 160 Convent Avenue, New York 10031

Abstract. Two-photon (2P) excitation of the second singlet (S_2) state was studied to achieve deep optical microscopic imaging in brain tissue when both the excitation (800 nm) and emission (685 nm) wavelengths lie in the “tissue optical window” (650 to 950 nm). S_2 state technique was used to investigate chlorophyll α (Chl α) fluorescence inside a spinach leaf under a thick layer of freshly sliced rat brain tissue in combination with 2P microscopic imaging. Strong emission at the peak wavelength of 685 nm under the 2P S_2 state of Chl α enabled the imaging depth up to 450 μm through rat brain tissue. © The Authors. Published by SPIE under a Creative Commons Attribution 3.0 Unported License. Distribution or reproduction of this work in whole or in part requires full attribution of the original publication, including its DOI. [DOI: 10.1117/1.JBO.19.6.066009]

Keywords: two photon; second singlet excitation; tissue optical window; penetration depth; chlorophyll α .

Paper 140096RR received Feb. 17, 2014; revised manuscript received May 27, 2014; accepted for publication May 28, 2014; published online Jun. 26, 2014.

1 Introduction

In biological and biomedical studies, most of the events or functions occur in a complex tissue environment and ultimately need to be studied in preparations as intact as possible.^{1,2} It is also important to image as deep as possible in living tissues. In brain research, optical imaging technique is still the only way to study neural tissues with micrometer or submicrometer spatial resolution. New methods have been applied to image the brain with submicrometer spatial resolution, among them two-photon (2P) microscopy offers the advantages of deeper tissue penetration³ and less photodamage, such as phototoxicity and photobleaching, in comparison with conventional confocal microscopy. 2P microscopy offers micrometer scale resolution in the brain, whereas magnetic resonance imaging techniques are limited to a millimeter scale. To minimize strong scattering of visible light in tissue and to obtain high quality images of deeper layers of cortex, further investigation on 2P fluorescence technique becomes important.^{4,5} Previous approaches to increase imaging depth include optimization of photodetection and implementation of regenerative amplification multiphoton microscopy.^{6,7} In comparison with the traditional 2P technique, a newly developed technique is proposed in this study to achieve increased depth of imaging with both excitation and emission wavelengths falling within the “tissue optical window.”⁸

According to Beer’s law, the imaging intensity of the carrying photons (ballistic photons) is determined by the wavelength-dependent scattering length (l_s) and absorption length (l_a),

$$I_{\text{out}} = I_{\text{in}} \exp \left[- \left(\frac{L}{l_s} + \frac{L}{l_a} \right) \right], \quad (1)$$

where I_{out} is the intensity of transmitted light, I_{in} is the intensity of incident light, and L is the penetration depth. To reach a deeper layer of the tissue, a smaller absorption coefficient (l_a^{-1}) or scattering coefficient (l_s^{-1}) is required for imaging in the therapeutic optical window, also called the “tissue optical window,” in the range from far-red to near infrared (NIR, 650 to 950 nm). Our previous study by Pu et al.⁸ conducted experiments on Chl α -coated beads using a 2P microscope to demonstrate and observe S_1 emission from S_2 excitation, but did not investigate any imaging depth in tissues. Under the current 2P microscopy technique, the wavelength to excite 2P fluorescence lies in the range of ~650 to 950 nm (red to infrared, low energy),^{9–11} which is within the “tissue optical window.” The probe agent’s emission wavelength, usually at 400 to 600 nm (low wavelength, high energy), limits the depth of imaging. When both the pumping and emission wavelengths are in the “tissue optical window,” an optimal tissue penetration depth will be reached. Nevertheless, the traditional 2P singlet (S_1) excitation cannot make both pumping and emission wavelengths fall within the NIR “tissue optical window” at the same time.

The objective of this study was to test the hypothesis that by exciting S_2 state fluorescent agents with both pumping and emission wavelength in the “tissue optical window,” the imaging depth in tissue is increased as compared to the traditional technique using the S_1 state for imaging in brain tissue.

2 Materials and Methods

Our study utilized spinach leaves covered by fresh rat brain slices at different thicknesses, and imaged the chlorophyll α (Chl

*Address all correspondence to: Robert R. Alfano, E-mail: ralfano@ccny.cuny.edu

α) fluorescence penetrating the brain tissue layer by using 2P fluorescence and S_2 technique. All procedures and animal use were approved by the Institutional Animal Care and Use Committee of the City College of New York.

2.1 Preparation of Spinach Leaf

Spinach leaves were purchased fresh from the local market. Each selected fresh spinach leaf was glued onto a microscope slide. The fresh leaf contains the light-absorbing molecule Chl α and plant organelle chloroplast, which are essential for the process of photosynthesis. It is known that the Chl α strongly absorbs red and blue-violet light from S_1 and S_2 bands to give the green color of leaves. The absorption of photons could drive the molecules of Chl α from the ground (S_0) state to the first singlet (S_1) or excited (S_2) state, converting photon energy into electronic excitation. There are three ways to obtain the emission of Chl α in far-red light of ~ 680 nm, (1) S_1 excitation caused by red light at a wavelength of about 630 nm, (2) S_2 excitation by violet light at a wavelength of 404 nm,¹² or (3) S_2 excitation by 2P at a wavelength of 800 nm, which gives

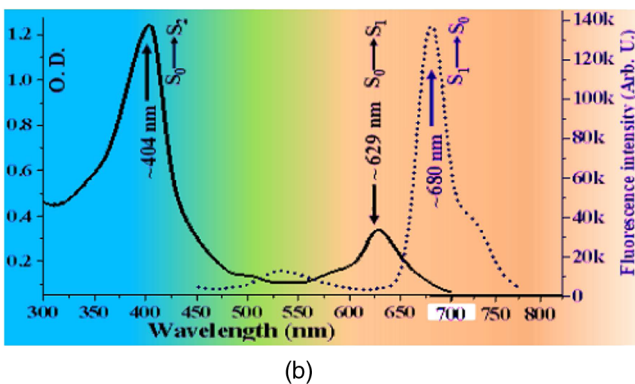
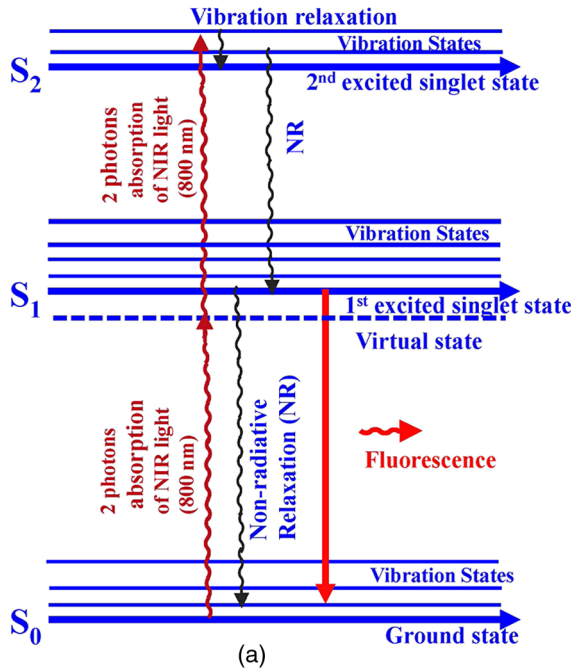

Fig. 1 (a) Jablonski diagram of energy level that was pumped to S_1 and S_2 excited singlet state by 1P or 2P absorption; (b) Chl α spectra of measured absorption (solid line) and fluorescence (dotted line).

a nonradiative process from S_2 to S_1 following 2P excitation. Figure 1 illustrates the mechanism of one-photon (1P) and 2P excitation of S_1 and S_2 bands of Chl α [Jablonski energy level diagram, Fig. 1(a)], and the measured absorption and fluorescence spectra of Chl α [Fig. 1(b)].

The absorbed photons excite Chl α from the ground state (S_0) to the S_1 or S_2 excited states, converting photon energy into electronic excitation. The decay of excited Chl α to the S_0 state can be achieved by emitting photons from S_1 directly or after the nonradiative process from S_2 to S_1 . The latter plays a key role in 2P-excited S_2 for deep imaging.

2.2 Preparation of Brain Tissue Sample

A Wistar rat (P10) was decapitated, the brain was transferred into a chilled oxygenated Ringer solution containing (in millimolar) (126 NaCl; 2.5 KCl; 1.25 NaH_2PO_4 ; 2 CaCl_2 ; 1 MgCl_2 ; 10 glucose; 26 NaHCO_3 ; 5 pyruvate; pH 7.40 to 7.45) and then was rapidly embedded in 2% low melting point agarose and processed for coronal sectioning using a compresstome (VF300, Precisionary Instruments, Greenville, North Carolina). Brain tissue slices (in an elliptical shape, $\sim 6 \times 5$ mm² for long and short diameters, respectively) were cut at the thicknesses of 200, 400, 450, and 500 μm , and then were quickly transferred one at a time to a gridded container filled with oxygenated Ringer solution.

Each brain slice was carefully placed on top of a fresh spinach leaf and a cover slip was placed on top of the brain tissue. Chlorophyll α in fresh spinach leaf samples was imaged with 2P microscopy. Experiments were conducted one by one on the samples covered by 0, 200, 400, 450, and 500- μm -thick brain tissues, respectively. All sample preparations and measurements were performed at room temperature.

2.3 Multiphoton Microscope and Image Collection

Twelve-bit two-dimensional images were captured by a multiphoton microscopy system (Prairie Technologies Inc., Middleton, Wisconsin) equipped with a Ti:Sapphire femtosecond laser source (<140 fs, Coherent Inc., Santa Clara, California), as illustrated in Fig. 2. The excitation wavelength 800 nm was used to achieve the 2P pumping S_2 band of 400 nm and to accomplish fluorescence imaging in Chl α 's spectral range of around

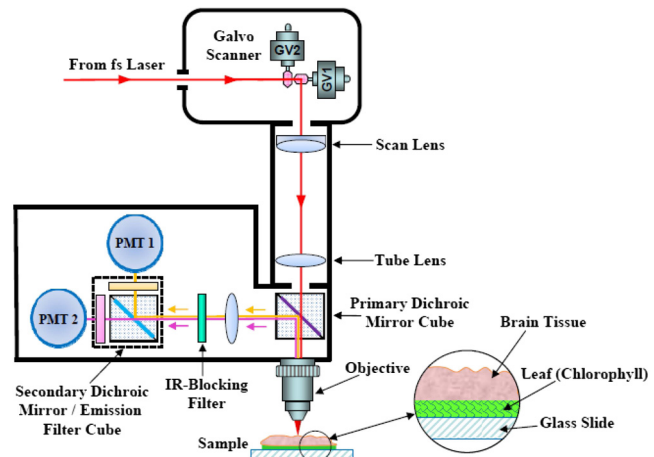

Fig. 2 Schematic diagram of the two-photon microscopy system for the second singlet (S_2) state excitation.

680 nm. This is the optimal condition for studying 2P S_2 excitation of Chl α due to the strong S_1 band absorption and emission at 680 nm. Images of spinach leaves, with regions of interest (ROIs) $469.5 \times 469.5 \mu\text{m}^2$ and 512×512 resolution, were obtained by the 2P microscope with a water immersion objective lens (20 \times , NA = 0.5, Olympus, Center Valley, Pennsylvania) through two-different photomultiplier tube channels, a testing channel and a control channel outfitted with a wide band filter of 685 ± 40 and 525 ± 35 nm (Chroma Technology, Bellows Falls, Vermont), respectively, while other imaging parameters were kept constant.

3 Results and Discussion

Figure 3 shows 2P microscopy images of the spinach leaf under the testing and control channels without any tissue covered. Red or green dots inside the cells were likely the chloroplast organelles which contain Chl α and other fluorescent molecules. The red channel represented the 2P S_2 state of Chl α and showed a much stronger peak at 685 nm. The 2P microscopy images of spinach leaves covered with 200, 400, and 450 μm freshly cut brain slices under testing and control channels are displayed in Figs. 4(a) and 4(b), 5(a) and 5(b), and 6(a) and 6(b), respectively. The 2P microscopy images of Chl α can be clearly observed under the testing channel with a 200 or 400- μm -thick brain tissue on top, but others cannot be clearly distinguished under the control channel. With a 450- μm brain tissue covering, the testing channel shows some vague profiles of Chl α but no profile visible in the control channel, indicating that brain tissue with a thickness of 450 μm is the maximum penetration depth for the Chl α at S_2 state among the slices prepared in our study, while the actual maximum penetration depth could be slightly deeper.

Figures 3 through 6 show the surface plots of emission intensity in the testing channel (panel c) and control channel (panel d). The vertical axis (z -axis) in these plots represents the fluorescent intensity. More regions show higher emission intensity in Figs. 3(c) through 6(c) than those in Figs. 3(d) through 6(d), indicating a much stronger emission intensity of the Chl α under the testing channel (685 nm) over the control channel (525 nm). These surface plot results demonstrate that the optimized 2P microscopy imaging of Chl α at 685 nm was exactly the strong fluorescence peak of Chl α under the 2P S_2 state, which leads to an excellent tissue penetration depth of more than 450 μm and with a much better image quality than that at 525 nm (control channel). Although the scattering properties of the brain tissue were likely changed shortly after it was cut into slices, experiments were conducted in a sufficiently oxygenated environment and in an acute way to keep the maximum penetration depth with limited variation and to avoid a reduction in the maximum penetration depth. The technique of combining 2P and S_2 to achieve deep tissue imaging can be further optimized and tested with *in vivo* experiments of the brain vasculature¹³ and neural structures.⁹

In order to quantify the emission through the tissue, in each image, five different ROIs with peak intensity were selected and another five ROIs were also selected from the background. The integrated light intensity of each region was calculated and then averaged for each image as I_{peak} and $I_{\text{background}}$. Figure 7 shows the normalized intensity $I_{\text{normalized}} = (I_{\text{peak}} - I_{\text{background}}) / I_{\text{background}}$ for each test group. As the thickness of the covering tissue increased from 0 to 400 μm , the intensity in the control channel dropped tremendously from 119 to 7, whereas that in the testing channel dropped from 183 to 140.

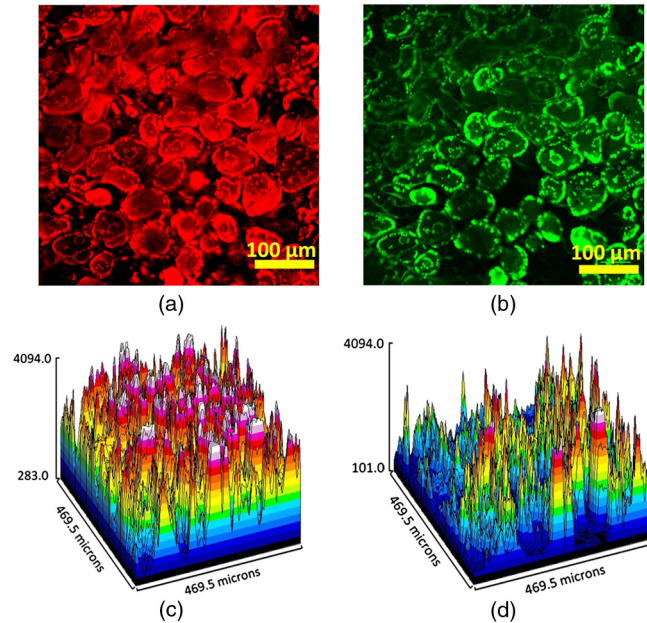

Fig. 3 2P microscopy images of Chl α in spinach leaf without covering tissue. The excitation wavelength was 800 nm. (a) Under 685 ± 40 -nm filter; (b) under 525 ± 35 -nm filter; (c) surface plot of the light intensity under 685 ± 40 -nm filter; (d) surface plot of the light intensity under 525 ± 35 -nm filter.

In contrast to diffusion optical tomography that studies the multiple scattering optical imaging,¹⁴ 2P microscopy technique explores the optical imaging using the ballistic and snake light within a number of single scattering events governed by Eq. (1). It is well-known that the depth resolution for light transporting in tissue depends on the scattering coefficient (μ_s) and

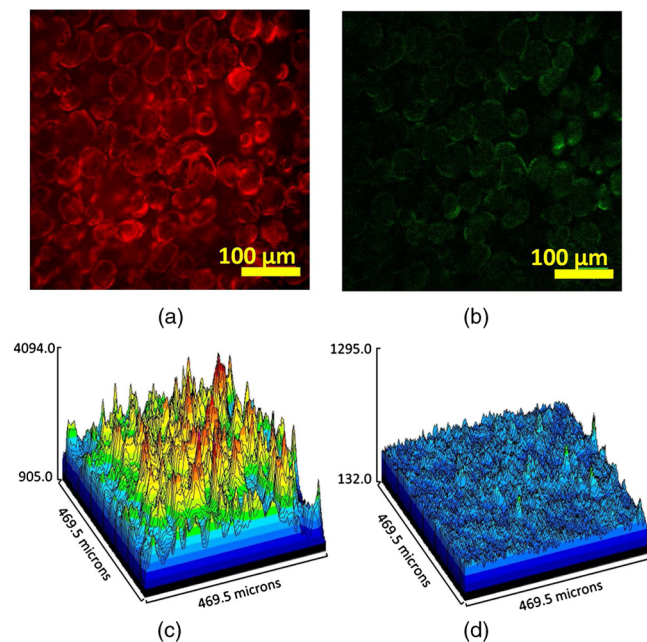

Fig. 4 2P microscopy images of Chl α in spinach leaf covered with 200- μm brain tissue. The excitation wavelength was 800 nm. (a) Under 685 ± 40 -nm filter; (b) under 525 ± 35 -nm filter; (c) surface plot of the light intensity under 685 ± 40 -nm filter; (d) surface plot of the light intensity under 525 ± 35 -nm filter.

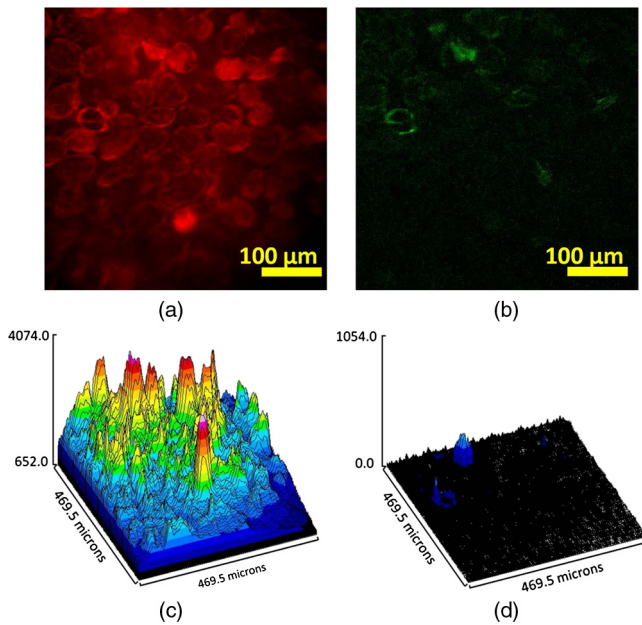

Fig. 5 2P microscopy images of Chl α in spinach leaf covered with 400- μm brain tissue. The excitation wavelength was 800 nm. (a) Under 685 \pm 40-nm filter; (b) under 525 \pm 35-nm filter; (c) surface plot of the light intensity under 685 \pm 40-nm filter; (d) surface plot of the light intensity under 525 \pm 35-nm filter.

absorption coefficient (μ_a). Within the range of far-red to near infrared, $\mu_s \gg \mu_a$ in tissue and their inverses lead to the penetration lengths in tissue, where $l_s (= 1/\mu_s)$ is the mean free scattering length and $l_a (= 1/\mu_a)$ is the absorption length. In tissue, the μ_s at 525 nm is larger than that at 685 nm, and therefore a higher depth resolution is expected for 685 nm over 525 nm in 2P

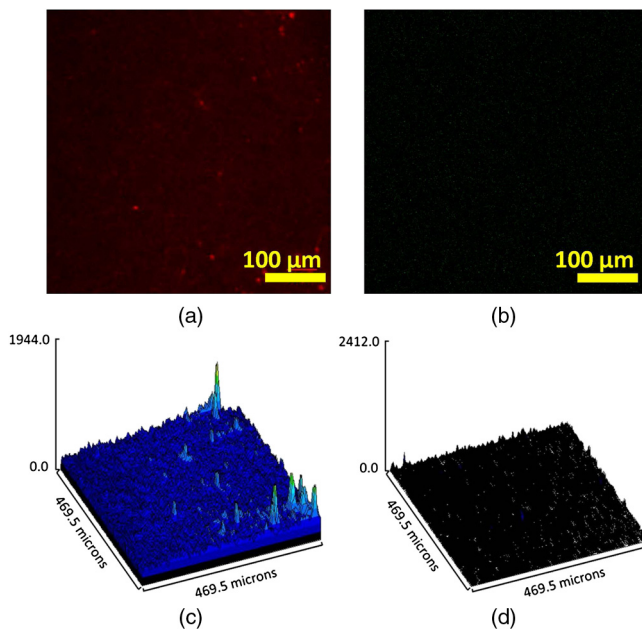

Fig. 6 2P microscopy images of Chl α in spinach leaf covered with 450- μm brain tissue. The excitation wavelength was 800 nm. (a) Under 685 \pm 40-nm filter; (b) under 525 \pm 35-nm filter; (c) surface plot of the light intensity under 685 \pm 40-nm filter; (d) surface plot of the light intensity under 525 \pm 35-nm filter.

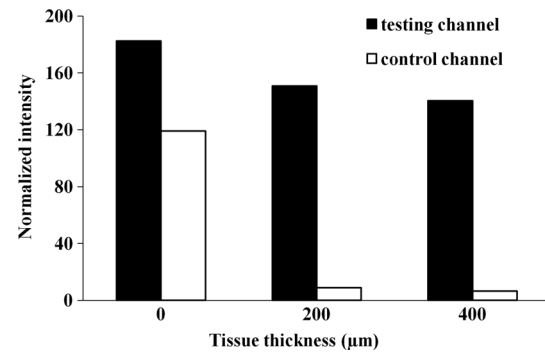

Fig. 7 Comparison of normalized peak intensity for the testing and control channels covered with 0, 200, and 400- μm -thick brain tissues.

microscopes. This led to the objective of the present 2P imaging depth study. In another study,¹⁵ the scattering coefficients were measured for fresh rat brain tissue at different wavelengths, the corresponding l_a and l_s can be calculated as 2 and 0.06 mm, respectively, at a wavelength of 525 nm, and 2.2 and 0.09 mm, respectively, at a wavelength of 685 nm. van der Zee et al.¹⁶ measured μ_a and μ_s of 40-week-old human brain gray matter; the corresponding l_a and l_s at a wavelength of 525 nm are calculated to be 5.88 and 0.02 mm, respectively, at a wavelength of 525 nm, and 20 and 0.025 mm, respectively, at a wavelength of 685 nm. Both studies evidence higher depth resolutions at a wavelength of 685 nm.

In our previous study,⁸ the intensity was almost zero under 525 nm as demonstrated in Fig. 4(b) in Ref. 8, since the beads were passively coated with Chl α by soaking in the Chl α -ethyl solution, which could lead to nonuniform distribution of Chl α on the surface of the beads, and did not present enough detectable signal from the shoulder emission at 525 nm. There are no accessory pigments in Chl α soaked beads. The present study used spinach leaves that contain cells and chloroplast organelles with a high concentration of Chl α and other accessory fluorophores, such as flavins (the emission peak of S_1 is close to 525 nm), such that detectable signals could be observed at 525 nm [Fig. 3(b)]. For the first time, the present study imaged Chl α through fresh rat brain tissue layers with 2P S_2 excitation where both the emission and excitation were in the “tissue optical window,” and can be applied for further studies.

4 Conclusions

The 2P S_2 excitation of Chl α in chloroplast of spinach leaf under brain tissue provides positive results for a deeper tissue imaging technique in comparison with a traditional 2P microscopy technique. Both the excitation and emission wavelengths fall within the “tissue optical window” and penetrate rat brain tissue up to 450 μm . This is the first study that applies a 2P S_2 state technique to investigate the imaging depth of Chl α inside rat brain tissue. This S_2 pumping technique can be potentially used as a reference for deeper and better quality images in future studies of brain blood vessels and neural tissue *in vivo*.

Acknowledgments

We thank Professor Bingmei Fu for providing partial support of Lingyan Shi. This research is supported in part by the Corning grant, Airforce Research Office (ARO), and City College internal funds to Robert Alfano. This research is also supported by Research Enhancement Award 5SC1HD068129 from the

Eunice Kennedy Shriver National Institute of Child Health and Human Development to Dr. Adrián Rodríguez-Contreras, and grants from the National Center for Research Resources (2G12RR03060-26A1) and the National Institute on Minority Health Disparities (8G12MD007603-27) from the National Institutes of Health.

References

1. F. Helmchen, W. Denk, and J. N. Kerr, "Miniaturization of two-photon microscopy for imaging in freely moving animals," *Cold Spring Harb. Protoc.* **2013**(10), 904–913 (2013).
2. M. Oheim et al., "Two-photon microscopy in brain tissue: parameters influencing the imaging depth," *J. Neurosci. Meth.* **111**(1), 29–37 (2001).
3. Y. Guo et al., "Noninvasive Two-photon-excitation imaging of tryptophan distribution in highly scattering biological tissues," *Opt. Commun.* **154**(5–6), 383–389 (1998).
4. F. Helmchen et al., "In vivo dendritic calcium dynamics in deep-layer cortical pyramidal neurons," *Nat. Neurosci.* **2**(11), 989–96 (1999).
5. S. Charpak et al., "Odor-evoked calcium signals in dendrites of rat mitral cells," *Proc. Natl. Acad. Sci. USA* **98**(3), 1230–1234 (2001).
6. P. Theer and W. Denk, "On the fundamental imaging-depth limit in two-photon microscopy," *J. Opt. Soc. Am. A. Opt. Image Sci. Vis.* **23**(12), 3139–3149 (2006).
7. W. Mittmann et al., "Two-photon calcium imaging of evoked activity from L5 somatosensory neurons in vivo," *Nat. Neurosci.* **14**(8), 1089–1093 (2011).
8. Y. Pu et al., "Two-photon excitation microscopy using the second singlet state of fluorescent agents within the tissue optical window," *J. Appl. Phys.* **114**(15), 153102 (2013).
9. W. Denk, J. H. Strickler, and W. W. Webb, "Two-photon laser scanning fluorescence microscopy," *Science* **248**(4951), 73–76 (1990).
10. M. Oheim et al., "Principles of two-photon excitation fluorescence microscopy and other nonlinear imaging approaches," *Adv. Drug Del. Rev.* **58**(7), 788–808 (2006).
11. A. Diaspro, G. Chirico, and M. Collini, "Two-photon fluorescence excitation and related techniques in biological microscopy," *Quart. Rev. Biophys.* **38**(2), 97–166 (2005).
12. S. Frigerio, R. Bassi, and G. M. Giacometti, "Light conversion in photosynthetic organisms," Chapter 1 in *Biophotonics*, L. Pavesi and P. M. Fauchet, Eds., Springer-Verlag, Berlin, pp. 1–14 (2008).
13. L. Shi et al., "Quantification of blood-brain barrier solute permeability and brain transport by multiphoton microscopy," *J. Biomech. Eng.* **136**(3), 031005 (2014).
14. Y. Pu et al., "Spectral polarization imaging of human prostate cancer tissue using near-infrared receptor-targeted contrast agent," *Technol. Cancer Res. Treat.* **4**(4), 429–436 (2005).
15. M. Mesradi et al., "Experimental and analytical comparative study of optical coefficient of fresh and frozen rat tissues," *J. Biomed. Opt.* **18**(11), 117010 (2013).
16. P. van der Zee, M. Essenpreis, and D. T. Delpy, "Optical properties of brain tissue," *Proc. SPIE* **1888**, 454–465 (1993).

Lingyan Shi is a PhD candidate in the Biomedical Engineering Department at the City College of New York. Her research focuses on quantification of blood-brain barrier permeability and its regulation, drug delivery, the applications of two-photon deep tissue imaging using femtosecond laser pulses. Other research interests include understanding the functional interactions between neural cells and the brain vasculature, biomedical optics, ultrasound, condensed matter light interactions, and solar energy.

Adrián Rodríguez-Contreras is a biology assistant professor at the City College of New York. In 2008, he established the developmental neurobiology laboratory combining anatomical, electrophysiological, and two-photon microscopy tools to study brain development in rodents and barn owls. Other research interests include applying novel methods in fluorescence microscopy for *in vivo* studies, exploring the cellular mechanisms involved in the growth of brain tumors and understanding the functional interactions between neural cells and the brain vasculature.

Yury Budansky: Biography is not available.

Yang Pu, PhD, is an imaging specialist at the University of California at Irvine. He is a multidisciplinary researcher in the fields of biomedical optics and radiology. His research is concentrated on breaking two limits of optics: enhancing the resolution of microscope to break the limitation of diffraction and imaging deep organs of large animals and humans using optical technique.

Thien An Nguyen is a MS student under the tutelage of Dr. Robert Alfano of the Institute of Ultrafast Spectroscopy and Lasers at the CUNY City College. She is currently studying applications of spatial frequency and complex light.

Robert R. Alfano is a distinguished professor of science and engineering at the City College of CUNY. He has pioneered many applications of light and photonics technologies to the study of biological, biomedical and condensed matter systems, invented and used in his research supercontinuum and novel tunable solid-state lasers. He has received his PhD in physics from New York University and is a fellow of the American Physical Society, Optical Society of America, and IEEE.